

- enter a number from 00 to 99 to programme activation time of relay 1 (enter 00 to deactivate the relay)
- press key **A**
- enter a number from 00 to 99 to programme activation time of relay 2 (enter 00 to deactivate the relay)
- press key **A**
- enter a number from 00 to 03 to programme activation mode of relay 1 (for code selection refer to "operating modes and programming codes")
- press key **A**
- enter a number from 00 to 03 to programme activation mode of relay 2 (for code selection refer to "operating modes and programming codes")
- press key **A** (red LED flashes)
- enter 55
- press key **A** (red LED off)

**Restoring the default programming**

- To delete all the programmed codes and restore the keypad default programming (for the codes refer to "default programming"):
- switch off the keypad
  - switch on the keypad again holding key **B** pressed until you hear the confirmation tone.

**Notes:**

- Write down the programming code and the relay activation codes in the table.
- The relay activation codes can only be changed by knowing the programming code.
- An acoustic signal indicates key pressing.
- If the entered code is not correct, you hear a dissuasion tone (keys are deactivated for 2 seconds).
- Press **A** during programming if you do not want to change a code. This allows you to go to the next programming operation without changing the code.
- The programming code and the relay activation codes must be different.
- Press **B** to cancel the last number you have entered.

**OPERATION**

- Enter the code of the relay to be activated.
- Press key **A** to confirm the code. If the code is correct, the relay activates (green LED on) with the programmed time and operating mode.

**Notes:**

- Press key **B** to delete an incorrect code before confirming it.
- If you enter an incorrect code and confirm it with key **A** you hear a dissuasion tone (keys are deactivated for approx. 3 seconds). This time increases up to a max. of 30 seconds each time an incorrect code is entered.
- The numbers entered and not confirmed with key **A** are deleted automatically 25 seconds after the last key you have pressed.

**BISTABLE OPERATION**

This function is possible only if the keypad has been programmed properly. See "Changing the relay activation time and mode".

To activate the relays for indefinite time:

- enter one of the codes for the relay to be activated
- press key **A** (green LED on). The relay activates for indefinite time.
- enter the code again to deactivate the relay
- press key **A** (green LED off and relay deactivation).

**DIRECTACTIVATION**

Press key **A** to activate the relays directly (this function is possible only if the keypad has been programmed properly. See "Changing the relay activation time and mode"). Both the two relays are activated if both of them are programmed to be directly activated by key **A**.

**EXIT PUSH-BUTTONS**

Two buttons can be connected between terminals P1, P2 and ground in order to activate the two relays according to the programmed activation time and mode.

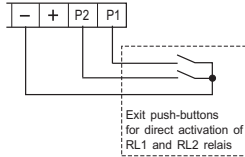

**EMERGENCY**

In case of power failure all the data are recorded in a nonvolatile memory and will not be lost.

**Red LED.**

Indication of programming mode.

**Green LED.**

Indication of code accepted.

**Key B.**

Clear.

**Key A.**

Enter and direct activation of relays (if programmed).

**Table of codes**

Master programming code

1 <sup>st</sup> code	<input type="text"/>
2 <sup>nd</sup> code	<input type="text"/>
3 <sup>rd</sup> code	<input type="text"/>
4 <sup>th</sup> code	<input type="text"/>
5 <sup>th</sup> code	<input type="text"/>
6 <sup>th</sup> code	<input type="text"/>
7 <sup>th</sup> code	<input type="text"/>
8 <sup>th</sup> code	<input type="text"/>
9 <sup>th</sup> code	<input type="text"/>
10 <sup>th</sup> code	<input type="text"/>
11 <sup>th</sup> code	<input type="text"/>
12 <sup>th</sup> code	<input type="text"/>
Activation time	<input type="text"/>
Activation mode	<input type="text"/>

1 <sup>st</sup> code	<input type="text"/>
2 <sup>nd</sup> code	<input type="text"/>
3 <sup>rd</sup> code	<input type="text"/>
4 <sup>th</sup> code	<input type="text"/>
5 <sup>th</sup> code	<input type="text"/>
6 <sup>th</sup> code	<input type="text"/>
7 <sup>th</sup> code	<input type="text"/>
8 <sup>th</sup> code	<input type="text"/>
9 <sup>th</sup> code	<input type="text"/>
10 <sup>th</sup> code	<input type="text"/>
11 <sup>th</sup> code	<input type="text"/>
12 <sup>th</sup> code	<input type="text"/>
Activation time	<input type="text"/>
Activation mode	<input type="text"/>

**Tone table**



**Installation of the push-button panel**

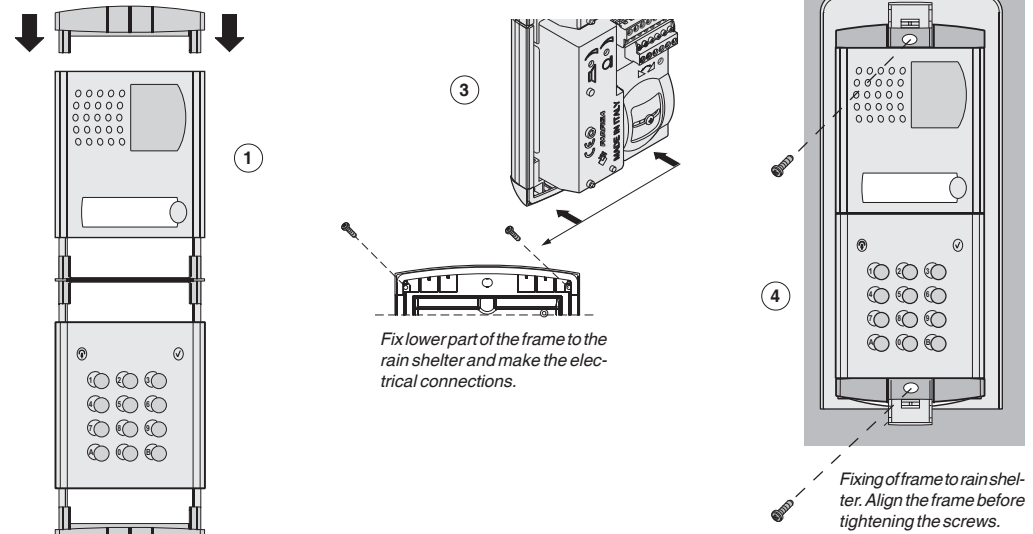

Mounting modules.

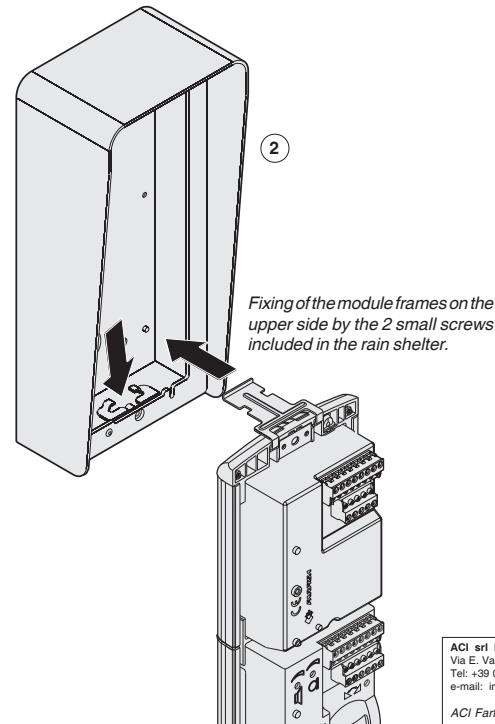

**ADJUSTMENTS**

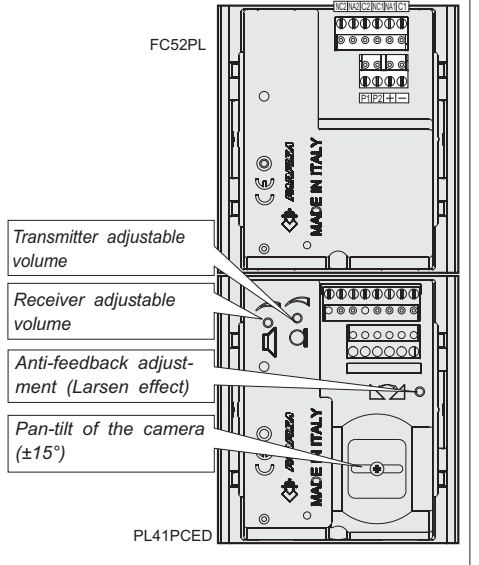

## INSTALLATION DIAGRAMS

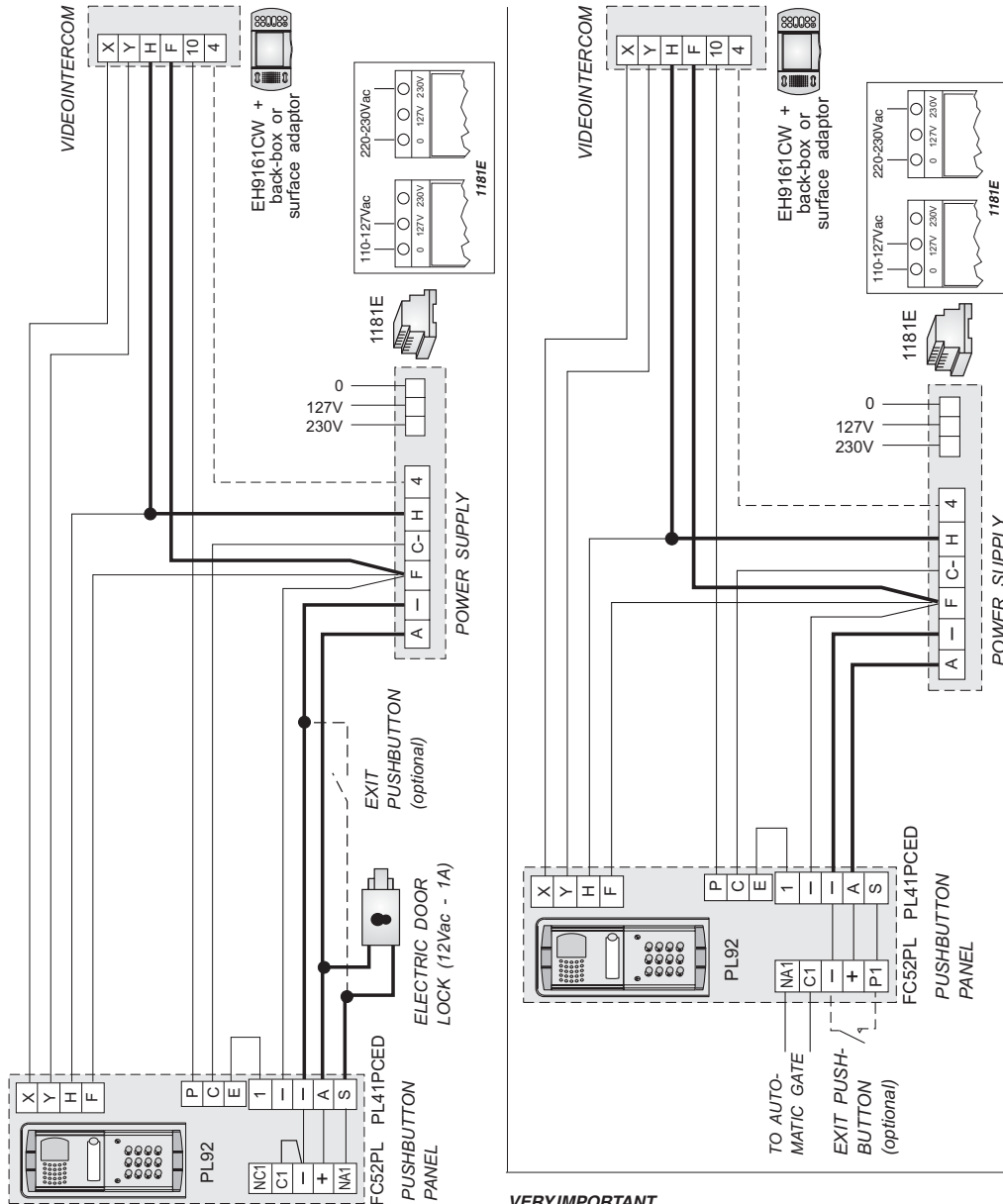

### VERY IMPORTANT

To comply with the European Standards on Electromagnetic Compatibility and to increase the reliability of the product, it is necessary to connect a suppression device when switching inductive loads i.e. electric releases and electric locks. The enclosed suppression devices (transil) must be connected as close as possible to the loads (ideally across the terminals. See figure).

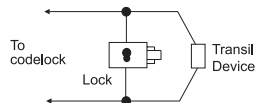

## CABLES

Terminals	Distance					
	50m (mm <sup>2</sup> )	165 Ft (AWG)	100m (mm <sup>2</sup> )	330 Ft (AWG)	200m (mm <sup>2</sup> )	660 Ft (AWG)
<b>X . Y</b>	0.35	22	0.35	22	0.35	22
<b>F . H . C . 4 . 10</b>	0.5	20	0.75	18	1	16
<b>(*) F . H</b>	0.75	18	1	16	2	14
<b>(*) A . -</b>	1.5	16	2.5	14	-	-

**Note.** For distances longer than 100m (330ft) max 200m (660ft) use twisted pair wire for conductors X and Y.

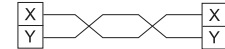

(\*) Cable in **bold face** type.

## ACCESS CONTROL KEYPAD

The keypad allows for the activation of 2 relays with programmable codes.

### Technical data

Power supply 12Vac/dc ±10%  
 Stand-by current 0.06A  
 Maximum current consumption 0.15A  
 Contact ratings 12Vac - 2A  
 Number of codes for relay 1 12 (+ direct activation)  
 Number of codes for relay 2 12 (+ direct activation)  
 Activation time for each relay from 1 to 99 sec. (or bistable)  
 Operating temperature 0° ÷ +40°C  
 Maximum allowable humidity 85% RH

### Terminals

**NC2** normally closed contact of relay 2  
**NA2** normally open contact of relay 2  
**C2** common contact of relay 2  
**NC1** normally closed contact of relay 1  
**NA1** normally open contact of relay 1  
**C1** common contact of relay 1  
**-** ground or alternate voltage input  
**+** positive or alternate voltage input  
**P2** activation of the relay 2; if momentarily connected to ground it allows the activation for the programmed time  
**P1** activation of the relay 1; if momentarily connected to ground it allows the activation for the programmed time

## PROGRAMMING

### Default programming

The article is supplied from the factory with the following codes:

Programming code: **11**  
 Activation code 1 of relay 1: **12345678**  
 Other activation codes of relay 1 (from 2 to 12): **none**  
 Activation time code of relay 1: **01** (1 sec.)  
 Operating mode of relay 1: **00** (monostable)  
 Activation code 1 of relay 2: **90**  
 Other activation codes of relay 2 (from 2 to 12): **none**

Activation time code of relay 2: **01** (1 sec.)  
 Operating mode of relay 2: **00** (monostable)

All codes are user-modifiable.

### Operating modes and programming codes

Monostable **00**  
 Bistable **01**  
 Monostable and direct activat. by key **A 02**  
 Bistable and direct activation by key **A 03**

### Changing the programming code

To change the programming code:  
 - enter the **actual programming code**  
 - press key **A** (red LED flashes)  
 - enter **00**  
 - press key **A** (red LED on)  
 - enter the new programming code with 1 to 8 digits (from 0 to 99999999)  
 - press key **A** (red LED flashes)  
 - enter **55**  
 - press key **A** (red LED off).

### Changing the activation codes of relay 1

To change the activation codes of relay 1:  
 - enter the **programming code**  
 - press key **A** (red LED flashes)  
 - enter **01** (identification code of relay 1)  
 - press key **A** (red LED on)  
 - enter a number with 1 to 8 digits to programme code 1 (from 0 to 99999999)  
 - press key **A**  
 - enter a number with 1 to 8 digits to programme code 2 (from 0 to 99999999)  
 - press key **A**  
 - enter a number with 1 to 8 digits to programme code 3 (from 0 to 99999999)  
 - press key **A**  
 - repeat the operation to programme all codes as necessary (max.12). When programming is completed press key **A** repeatedly until the red LED starts flashing  
 - enter **55**  
 - press **A** (red LED off).

### Changing the activation codes of relay 2

To change the activation codes of relay 2 follow the procedure described above, changing the relay identification code (**02** instead of **01**).

### Changing one relay activation code

To change one relay activation code, without modifying the others:

- enter the **programming code**
- press key **A** (red LED flashes)
- enter **01** or **02** (for relay 1 or 2, respectively)
- press key **A** (red LED on)
- press key **A** repeatedly to reach the code to be changed
- enter a number with 1 to 8 digits (from 0 to 99999999)
- press key **A** repeatedly until the red LED starts flashing
- enter **55**
- press key **A** (red LED off).

### Example

To change activation code 7 of relay 2:

- enter the **programming code**
- press key **A** (red LED flashes)
- enter **02**
- press key **A** (red LED on)
- press key **A** six times
- enter a number with 1 to 8 digits
- press key **A** six times (red LED flashes)
- enter **55**
- press key **A** (red LED off).

### Deleting one relay activation code

To delete one relay activation code, without modifying the others:

- enter the **programming code**
- press key **A** (red LED flashes)
- enter **90**
- press key **A** (red LED on)
- enter a 3-digit number "nxx"; n indicates the relay associated with the code to be deleted (1 or 2); xx indicates the code to be deleted (from 01 to 12)
- press key **A** (red LED flashes)
- enter **55**
- press key **A** (red LED off).

### Changing the relay activation time and mode

To change the relay activation time and mode:

- enter the **programming code**
- press key **A** (red LED flashes)
- enter **03**
- press key **A** (red LED on)